

1.4

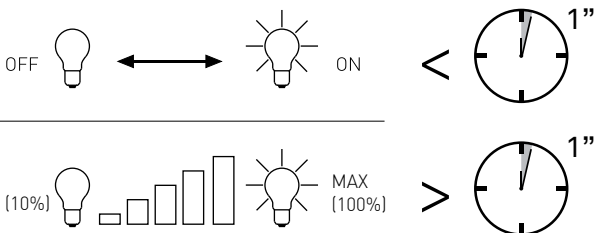

1.5

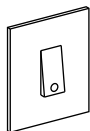
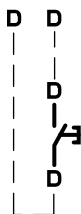
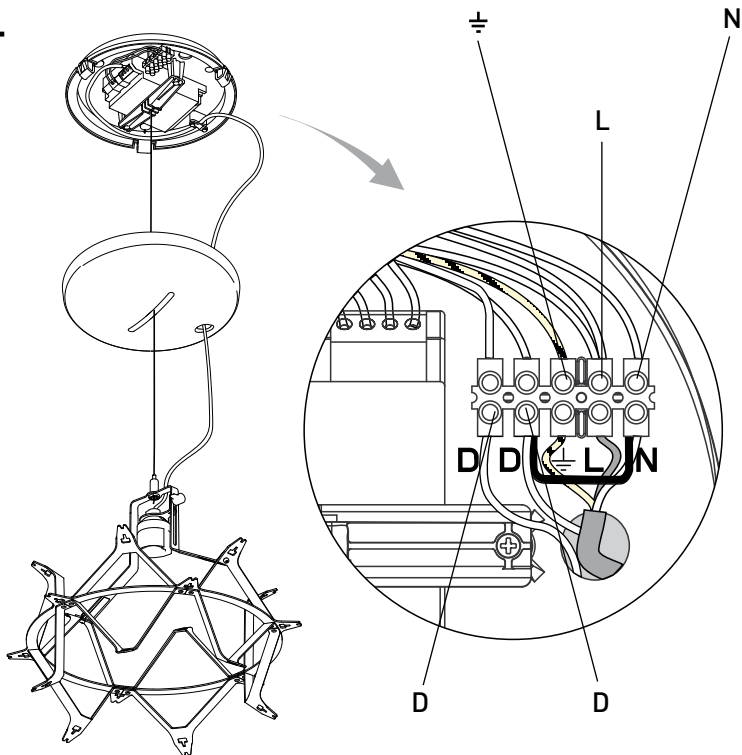
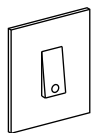
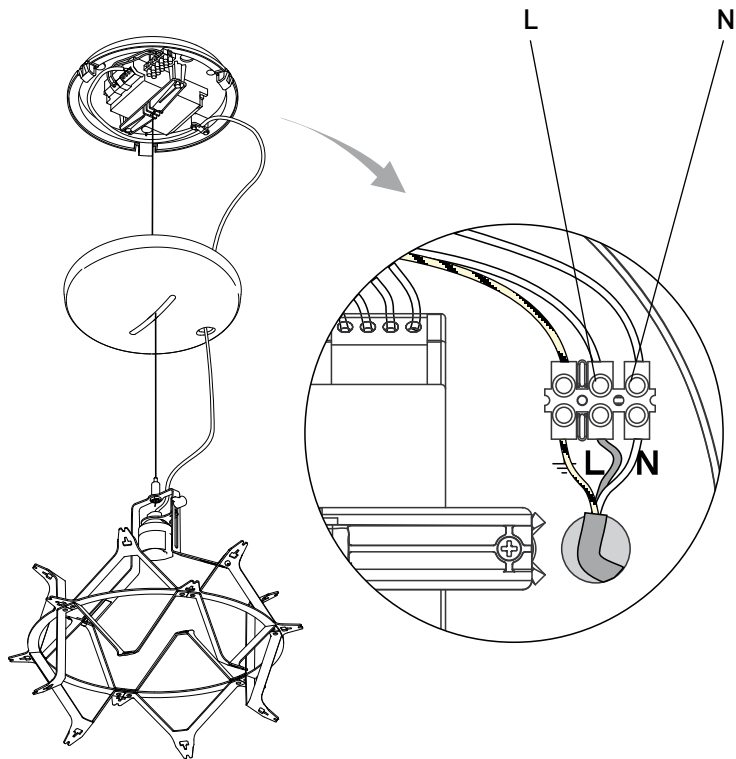

OFF

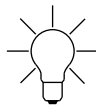

ON

2

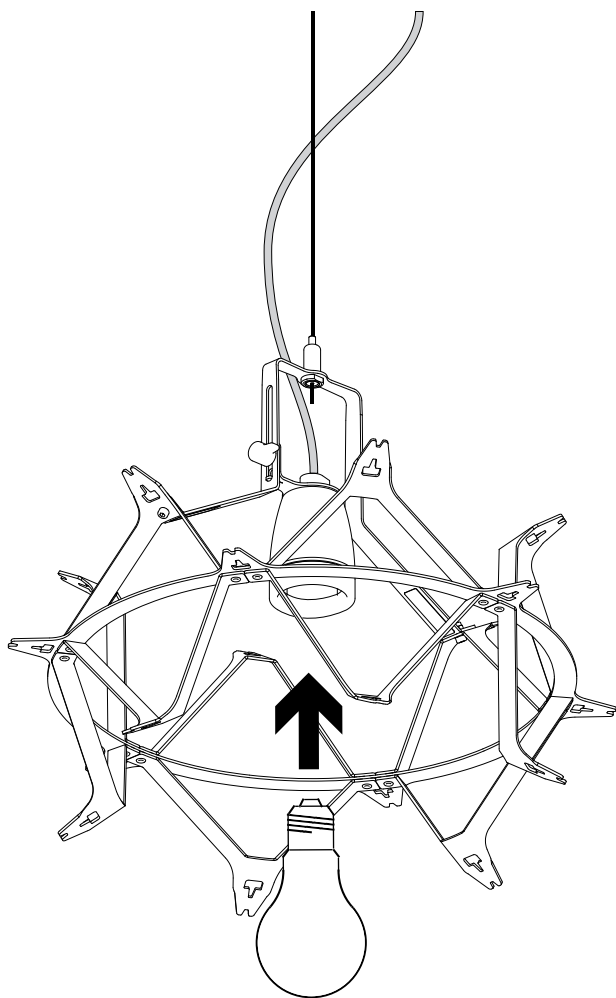

2.1

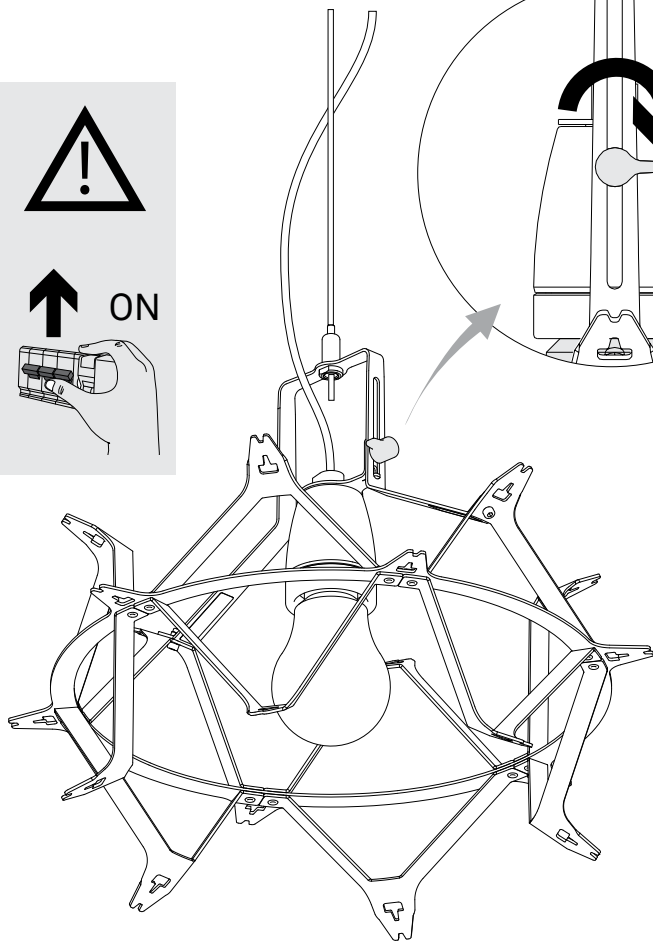
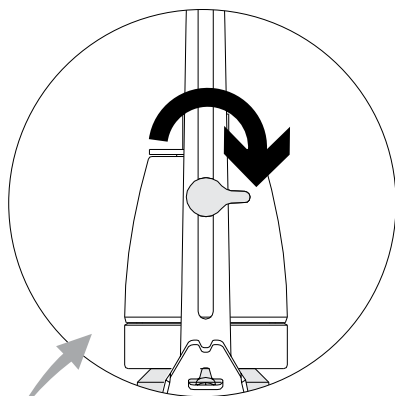
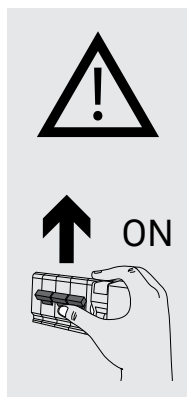

3

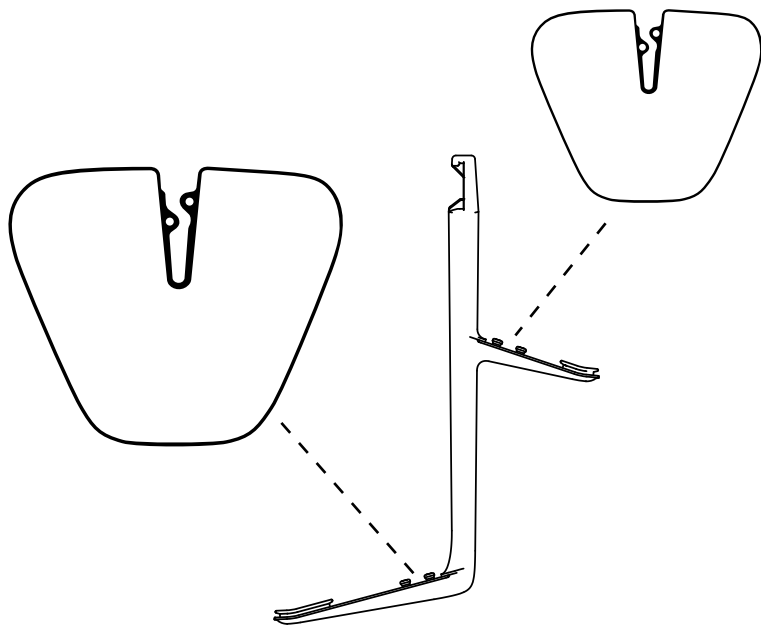

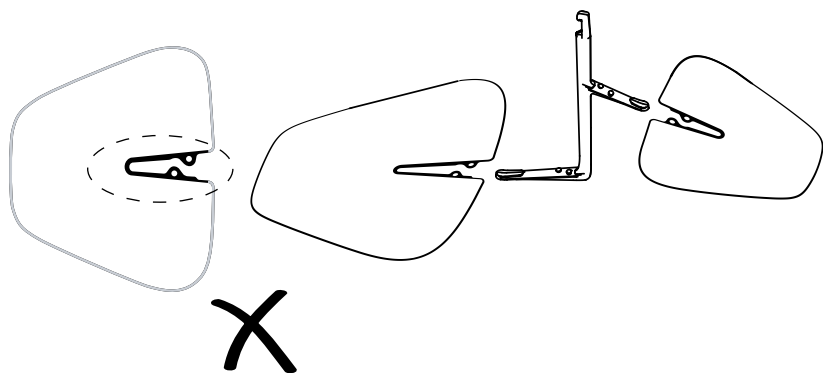
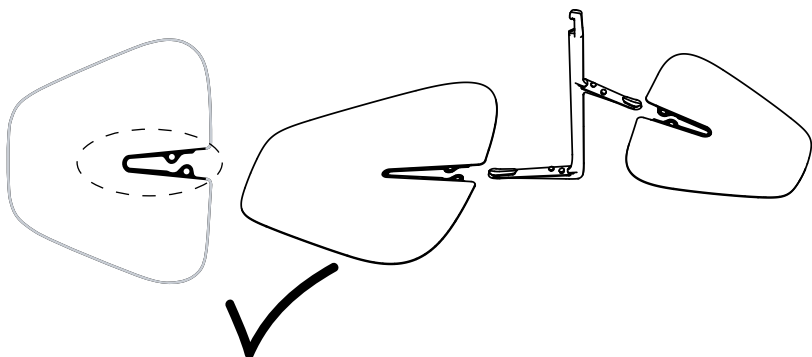
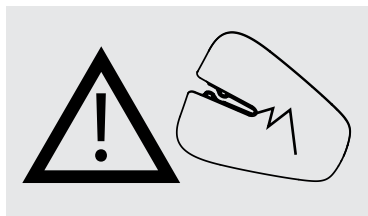

3.1

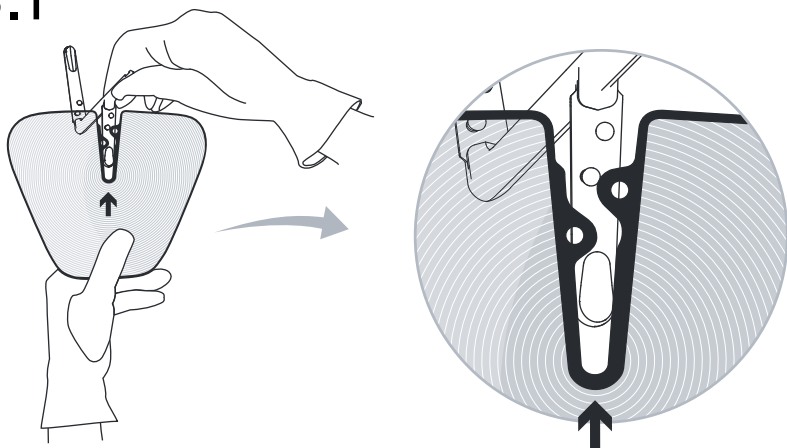

3.2

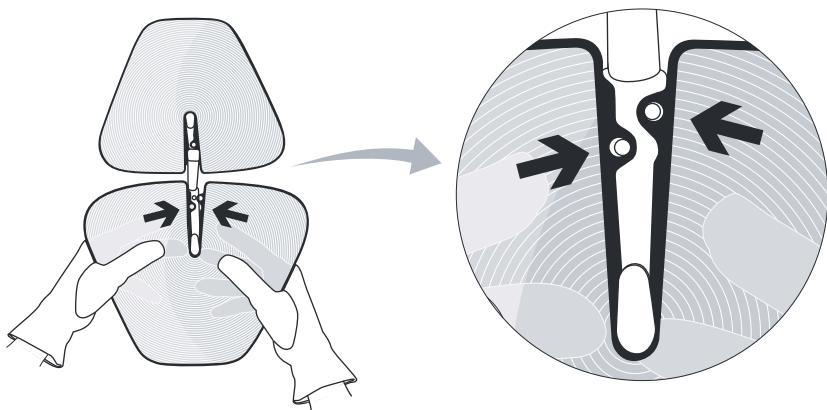

4

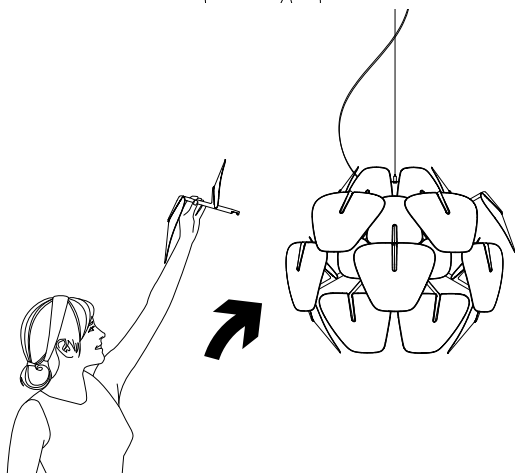
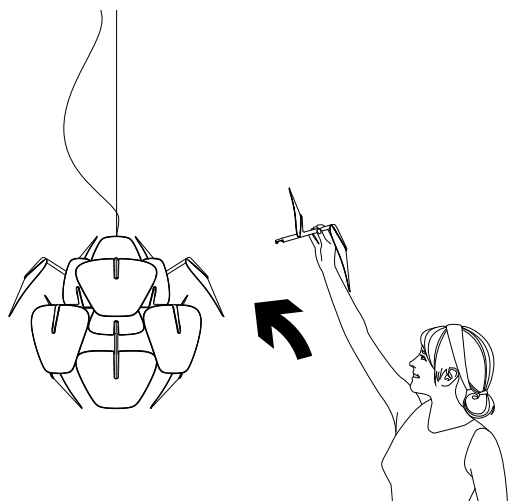

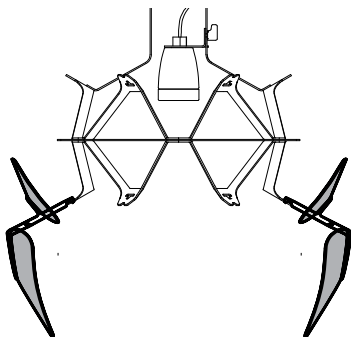

1.

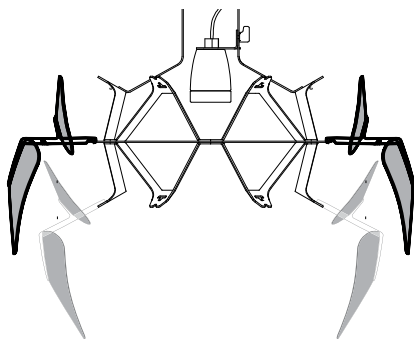

2.

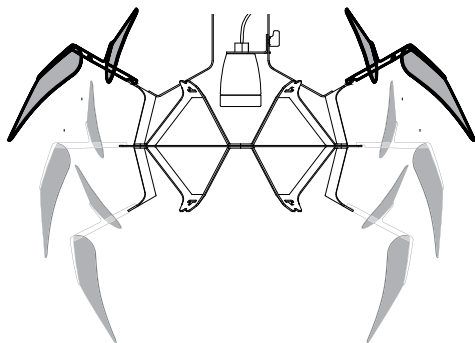

3.

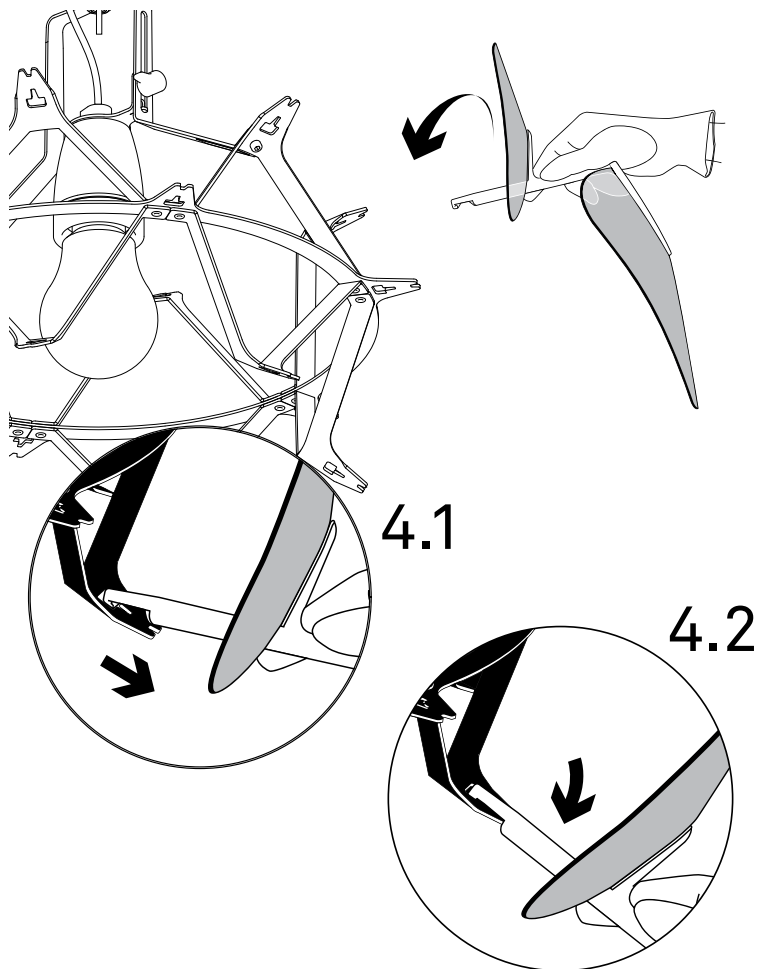

5

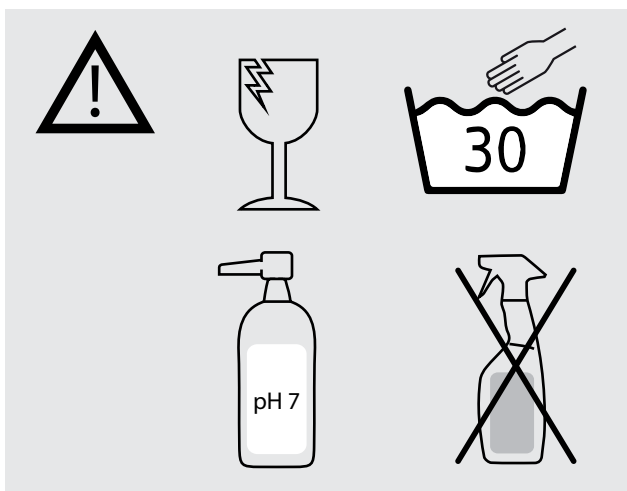
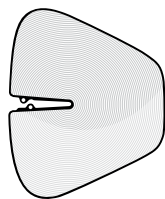
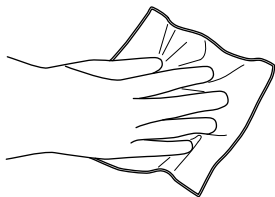

x1

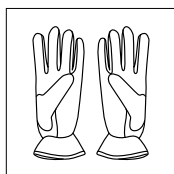

x2

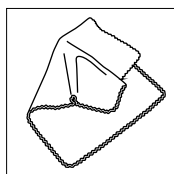

5.1

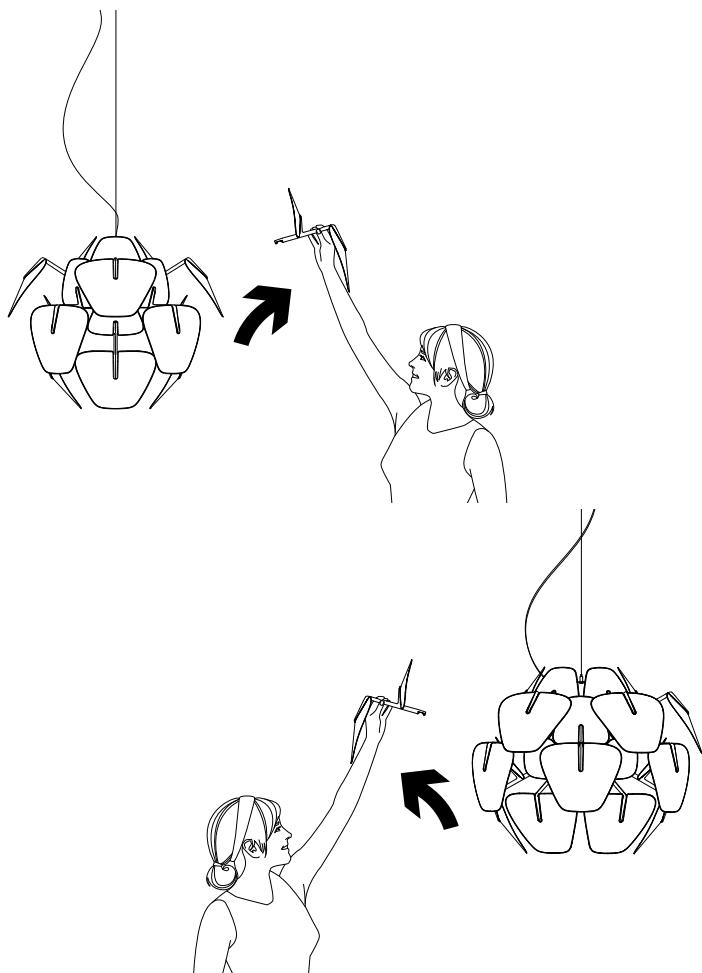

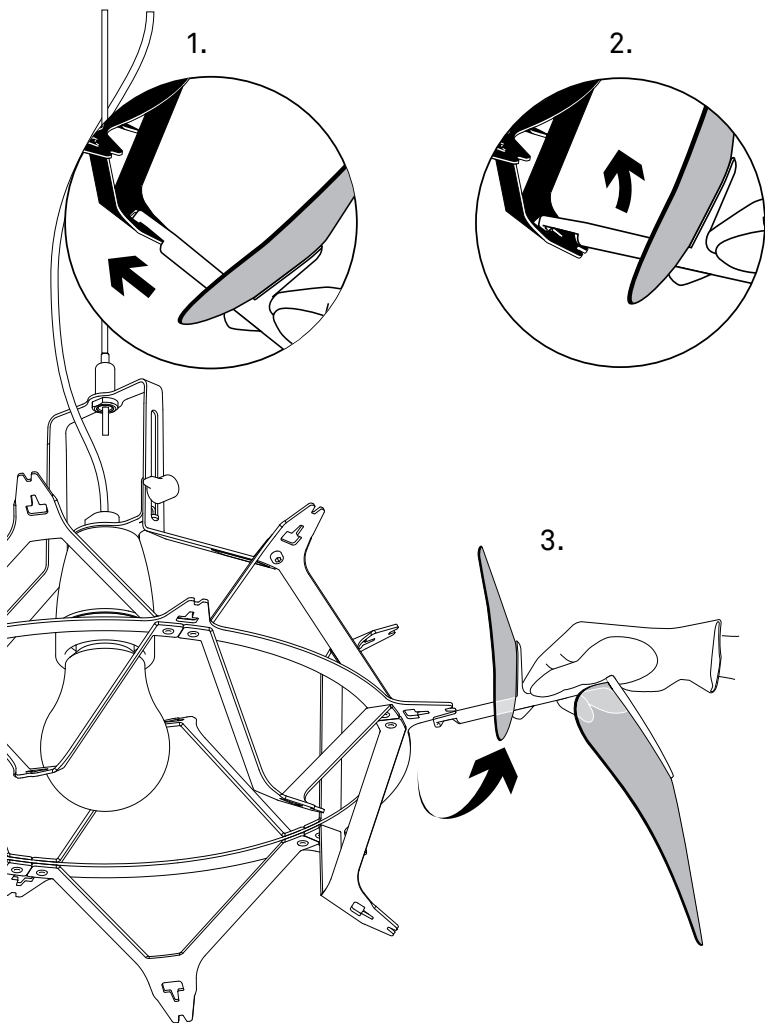

5.2

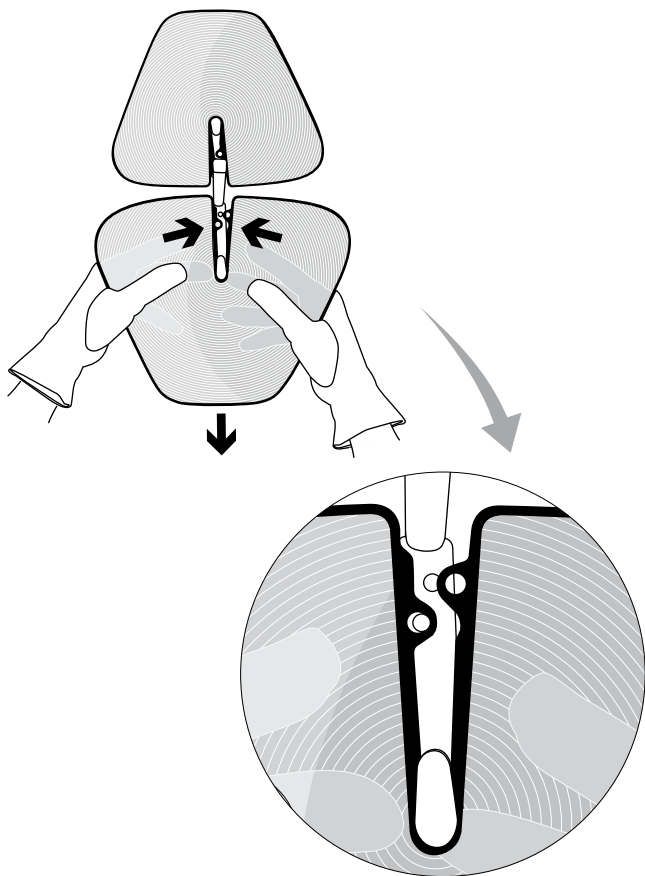

5.3

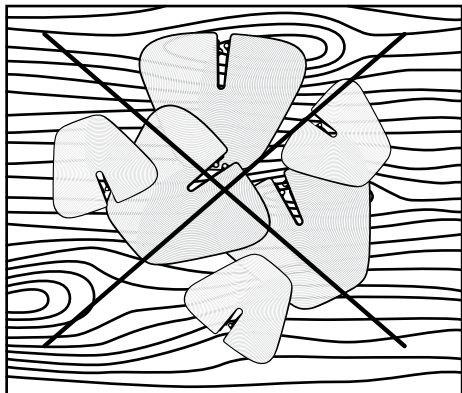

X

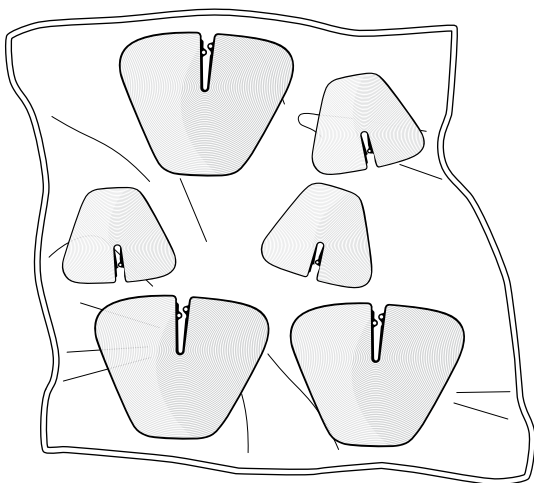

✓

5.4

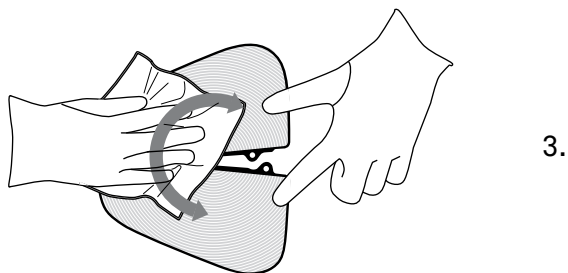
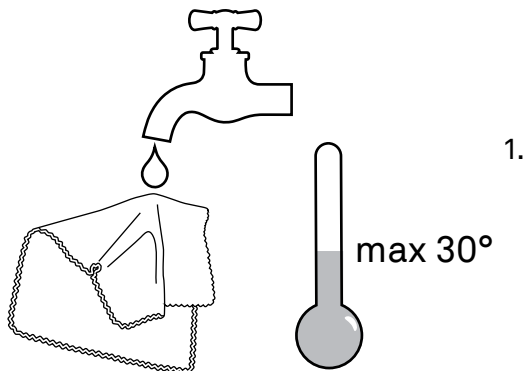

→ 3 |
(p. 19)



Luceplan Spa
Via E.T. Moneta 40
20161 Milano
Italia
T +39 02662421
F +39 0266203400
info@luceplan.com

Luceplan USA
14 Wooster Street
New York, NY 10013
infous@luceplan.com

www.luceplan.com



Quality System
Certificate
UNI EN
ISO 9001

D660I0211