

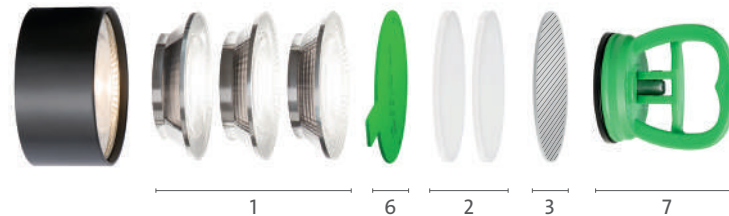

# ■ wi4-optisches Zubehör und Werkzeuge *wi4-optical accessories and tools*

STRAHLERKOPFZUBEHÖR SPOTLIGHT ACCESSORIES

TECHNISCHE DATEN TECHNICAL DATA		CE
1 Linsenoptik <i>lens optic</i>	spot 12° <i>wi4-li-12°</i> medium 24° <i>wi4-li-24°</i> flood 38° <i>wi4-li-38°</i>	
2 LSD Aufweitungsversatz Abstrahlwinkel vergrößern <i>LSD light shaping diffusor</i> <i>increase beam angles</i>	30° <i>wi4-vl-30°</i> 60° <i>wi4-vl-60°</i>	
3 SKL Skulpturenlinse (spot 12°) elliptische Lichtverteilung <i>SKL sculpture lens (spot 12°)</i> <i>elliptic light distribution</i>	14° x 52° <i>wi4-vl-sk</i>	
6 Silikonpad <i>silicone pad</i>	<i>wi4-sp</i>	
7 Saugheber <i>vacuum cup</i>	<i>sh1</i>	



**WICHTIG IMPORTANT**

Zubehör und Werkzeuge sind erhältlich bei mawa. Werkzeuge sollten entsprechend der Montageanleitung gewählt werden!

*Accessories and tools are available from mawa. Tools have to be chosen according to mounting manual!*

**!** WICHTIG: Pro Linseneinheit ist jeweils nur ein Zubehörteil kombinierbar.

**!** IMPORTANT: Only one accessory per lens unit can be combined.

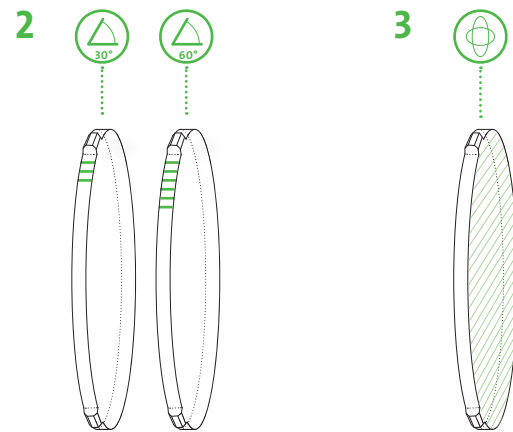
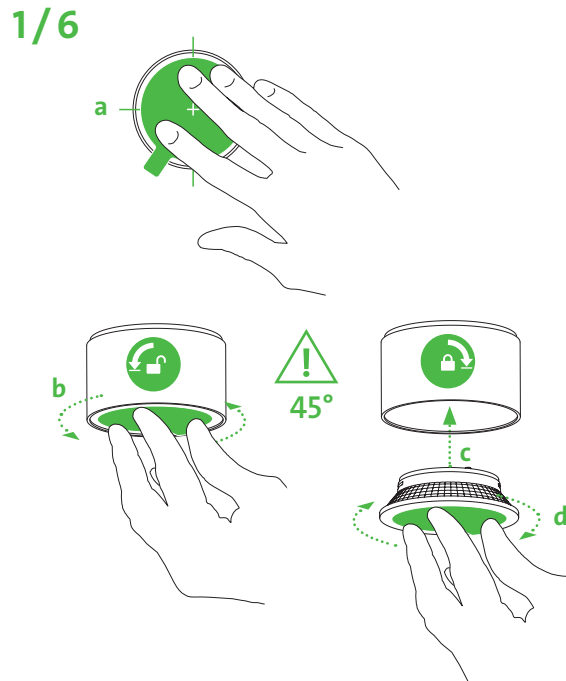

Linse	LSD 30°	LSD 60°
12° spot	32°	61°
24° medium	38°	64°
38° flood	48°	71°

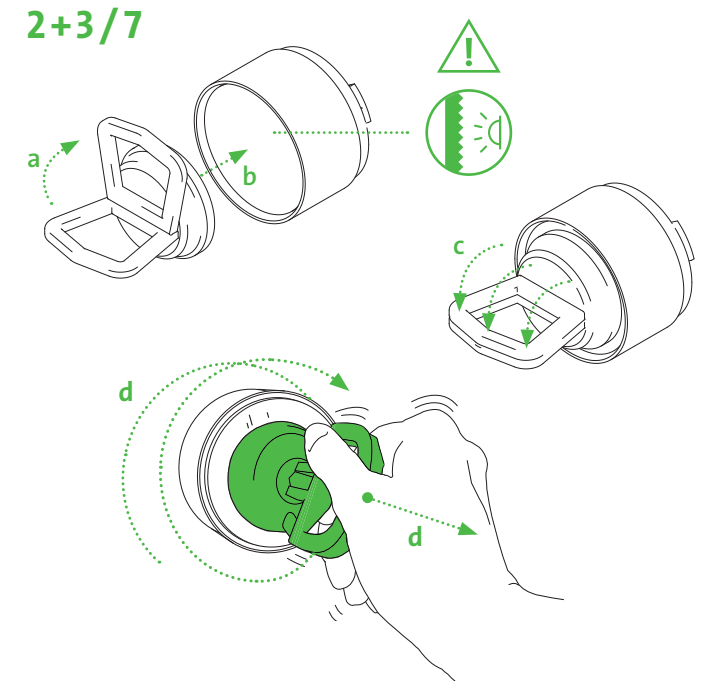



# ■ wi4 - shutter und wabenraster *wi4 - shutters and honeycomb*

STRAHLERKOPFZUBEHÖR SPOTLIGHT ACCESSORIES

TECHNISCHE DATEN	TECHNICAL DATA	CE
4 Wabenraster, schwarz <i>honeycomb, black</i> (für seitliche Entblendung) <i>(cleaner more balanced spread of light)</i>	<i>wi4-wa-s</i>	
5 Shutter (schwarz/weiß) <i>shutters (black/white)</i>		
19 mm symmetrisch <i>symmetrical</i>	<i>wi4-sh-s-9005/-9016</i>	
38 mm symmetrisch <i>symmetrical</i>	<i>wi4-sh-m-9005/-9016</i>	
19 – 76 mm asymmetrisch <i>asymmetrical</i>	<i>wi4-sh-las-9005/-9016</i>	
8 Handschuhe <i>cotton gloves</i>		

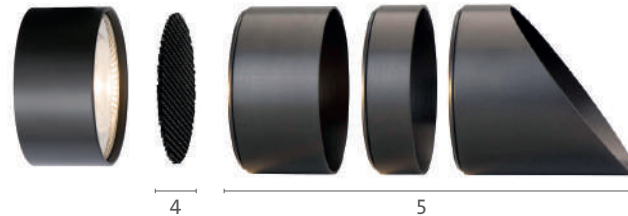

**WICHTIG** *IMPORTANT*

Zubehör und Werkzeuge sind erhältlich bei mawa. Werkzeuge sollten entsprechend der Montageanleitung gewählt werden!

*Accessories and tools are available from mawa. Tools have to be chosen according to mounting manual!*

**!** WICHTIG: Pro Linseneinheit ist jeweils nur ein Zubehörteil kombinierbar.

*IMPORTANT: Only one accessory per lens unit can be combined.*

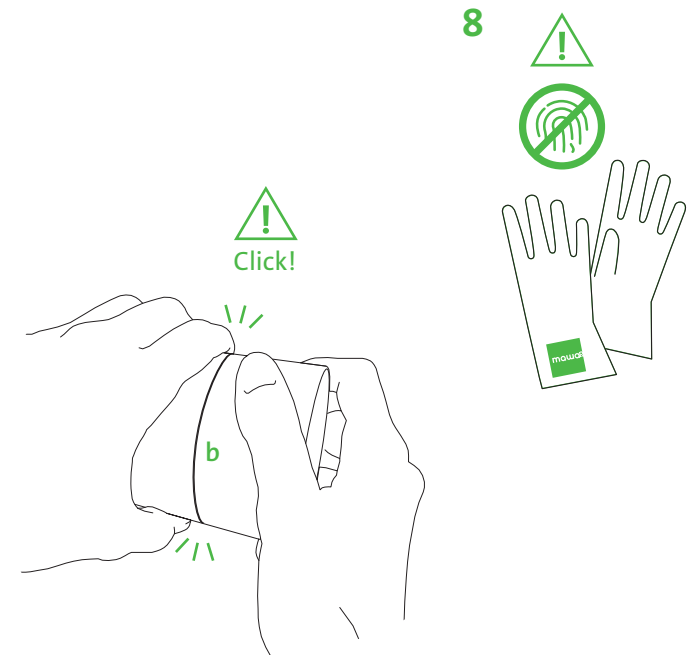
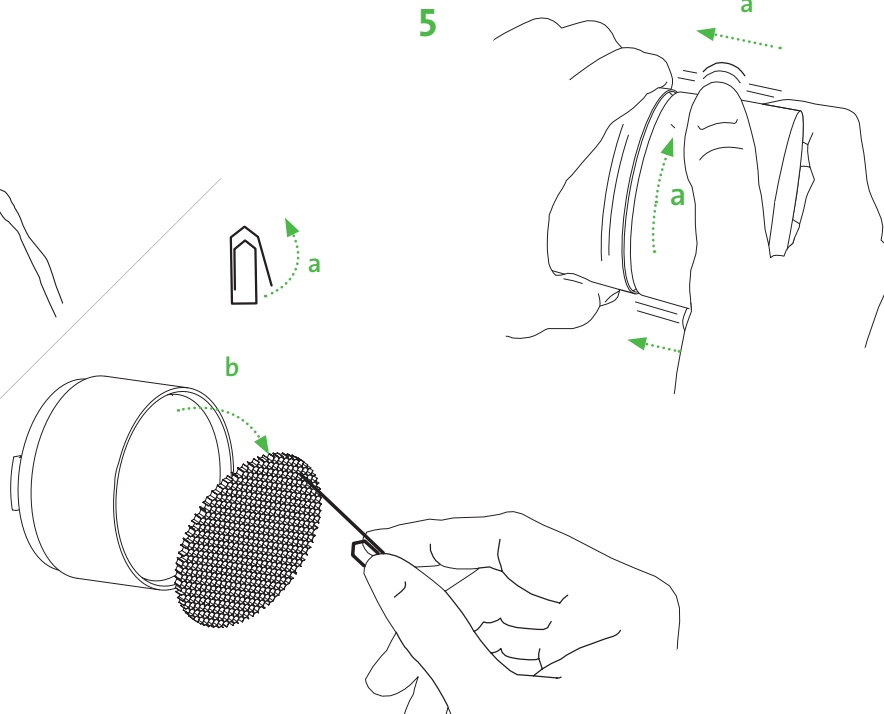
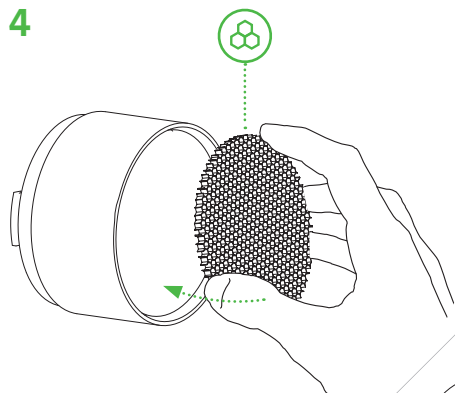



# ■ wi4-optisches Zubehör und Werkzeuge *wi4-optical accessories and tools*

STRAHLERKOPFZUBEHÖR SPOTLIGHT ACCESSORIES

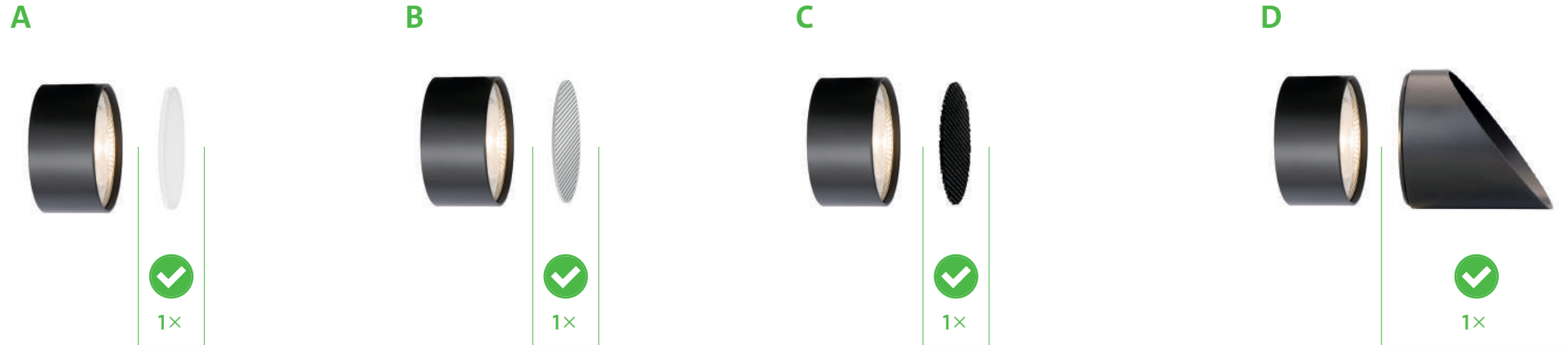

Wichtig: Bitte maximal 1 Zubehörteil pro Linseneinheit platzieren!  
*Important: Please combine max. 1 accessory per lens unit!*

