



## COMPONENTS OF PACKAGING:

glass shade, metal fixture, metal string pull, cotton gloves,  
installation manual

## WARNING:

**Installation must be carried out by a  
qualified electrician only.**

**Switch off power at main circuit panel  
prior to installation!**

**The manufacturer assumes no liability  
for damage occurring during transport  
or resulting from incorrect assembly.  
When unpacking the light, do so with**

**Instalation time: 30 minutes/1 person**



BROKIS®

BROKIS S.R.O.  
ŠPANIELOVA 1315/25  
163 00 PRAHA 6 - ŘEPY  
CZECH REPUBLIC

ORG. ID 64940799  
VAT ID CZ64940799  
C 42174 MĚSTSKÝ SOUD  
V PRAZE

TEL +420 567 211 517  
TECHNICAL@BROKIS.CZ  
INFO@BROKIS.CZ  
WWW.BROKIS.CZ

## 1. MOUNTING THE METAL FIXTURE

Pull the power cable through the opening in the metal fixture. Using screws and wall plugs (not included), mount the metal fixture on the wall. Care must be taken to ensure that the fixture is mounted perpendicular to the floor.

With regard to various types of walls, we recommend consulting installation with an expert. The manufacturer assumes no liability for incorrect installation or defects in the material to which the light is mounted.

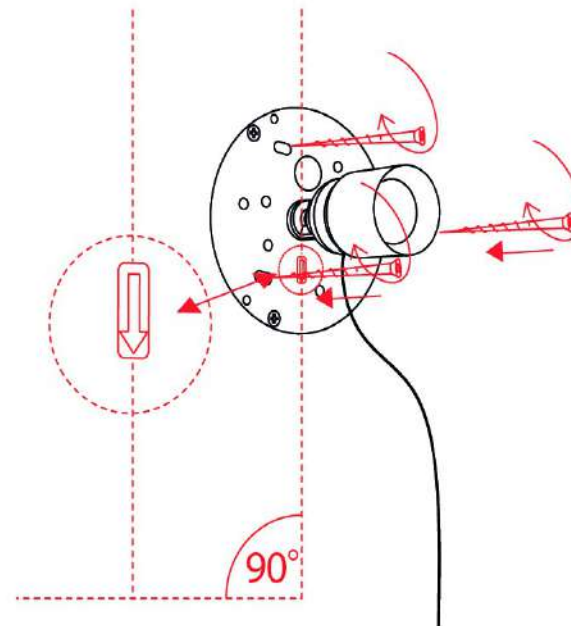
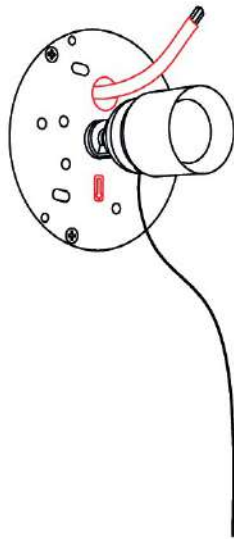

## 2. CONNECTING THE LIGHT TO THE BUILDING WIRING

Connect the light to the building wiring according to the connection diagram.

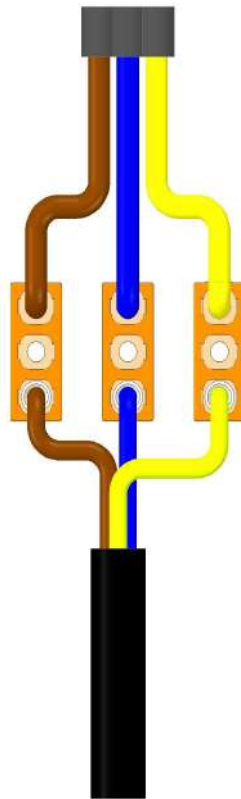

### 3. ATTACHING THE GLASS SHADE

Pass the string hanging from the metal light fixture through first the large opening and then the small opening in the glass shade.

Connect the ground wire with FASTON terminal to the shade mounting ring.

Position the glass shade on the metal light fixture so that the screws pass through the openings in the shade mounting ring. Gently rotate the glass shade clockwise until it is secured firmly to the metal light fixture.

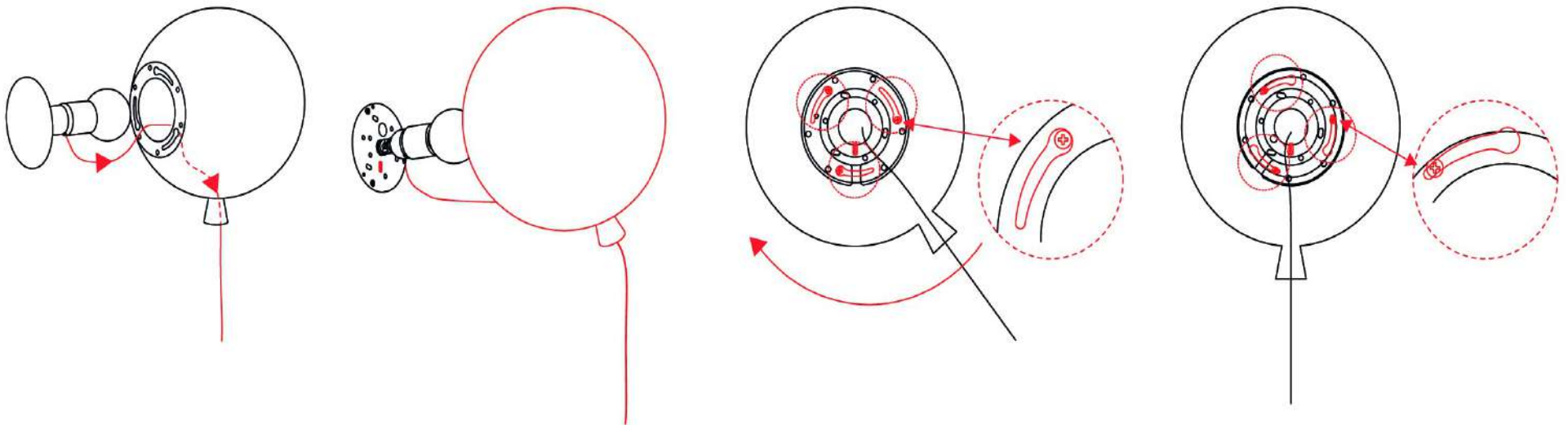

#### 4. INSTALLING THE LIGHT SOURCE

Install the light source (not included).

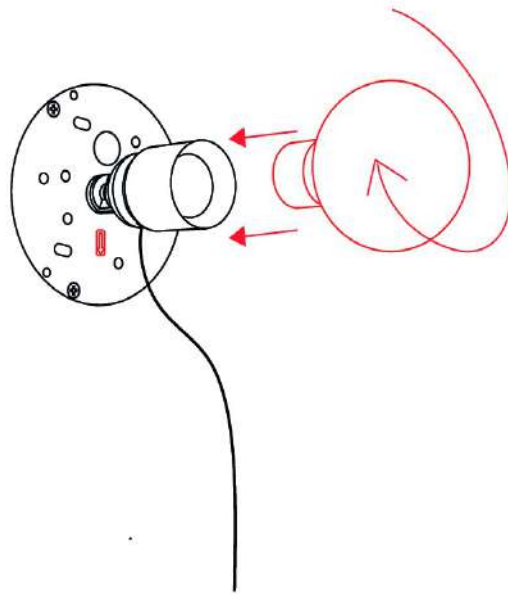

## 5. INSTALLING THE METAL STRING PULL

Pass the string through the metal string pull and secure with a knot.

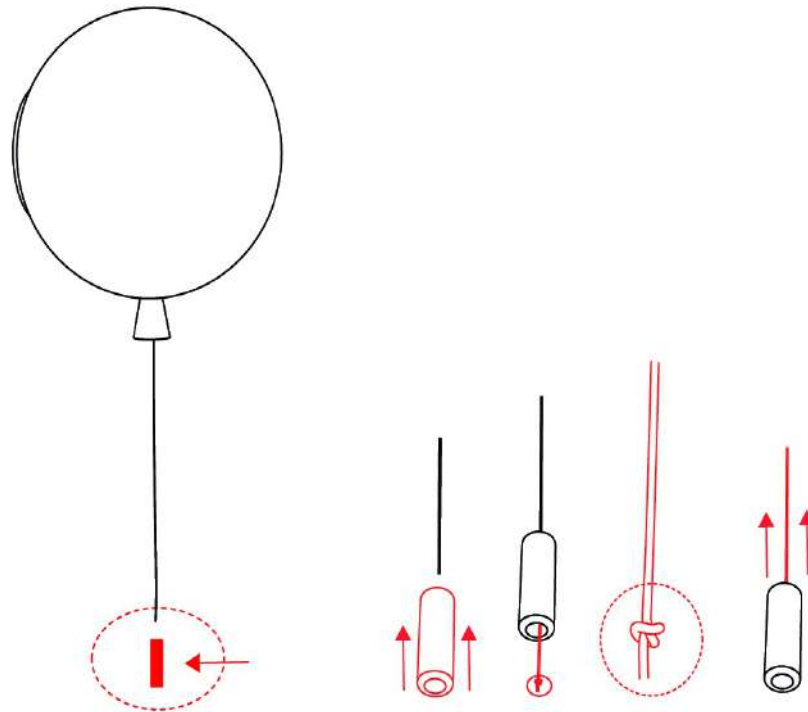

## 6. SWITCHING ON THE LIGHT

Restore power at the main circuit panel and verify that the light works properly.

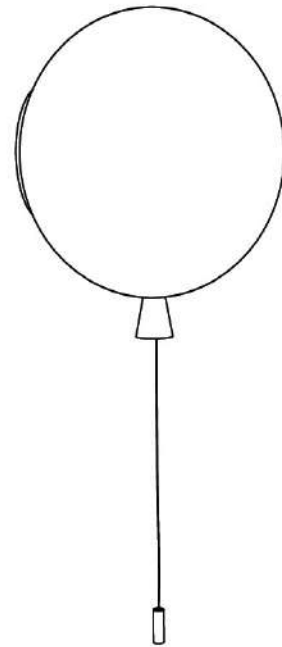



## CLEANING THE GLASS

**The light can be cleaned using common cleaning agents. Never use solvents or abrasives (scouring powder).**

**PRIOR TO SHIPPING, THE FUNCTIONALITY OF EACH LIGHT AND ITS COMPONENTS IS THOROUGHLY TESTED. THE MANUFACTURER ASSUMES NO LIABILITY FOR THE MISHANDLING OF PRODUCTS.**



**BROKIS®**

BROKIS S.R.O.  
ŠPANIĚLOVA 1315/25  
163 00 PRAHA 6 - ŘEPY  
CZECH REPUBLIC

ORG. ID 64940799  
VAT ID CZ64940799  
C 42174 MĚSTSKÝ SOUD  
V PRAZE

TEL +420 567 211 517  
TECHNICAL@BROKIS.CZ  
INFO@BROKIS.CZ  
WWW.BROKIS.CZ